



DC COMPONENTS CO., LTD.

RECTIFIER SPECIALISTS

SD820
THRU
SD8200

TECHNICAL SPECIFICATIONS OF SCHOTTKY BARRIER RECTIFIER

VOLTAGE RANGE - 20 to 200 Volts

CURRENT - 8.0 Amperes

FEATURES

- * Metal to silicon rectifier majority carrier conduction
- * Low power loss, High efficiency
- * High current capability
- * Low forward voltage drop
- * High surge capacity
- * For use in low voltage high frequency inverters, free wheeling, and polarity protection applications

MECHANICAL DATA

- * Case: Molded plastic
- * Epoxy: UL 94V-0 rate flame retardant
- * Terminals: Solder plated, solderable per MIL-STD-750, Method 2026
- * Mounting position: Any
- * Weight: 0.4 grams Approx.

MAXIMUM RATINGS AND ELECTRICAL CHARACTERISTICS

Ratings at 25°C ambient temperature unless otherwise specified.
Single phase, half wave, 60Hz, resistive or inductive load.
For capacitive load, derate current by 20%.

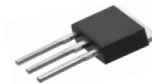

TO-251

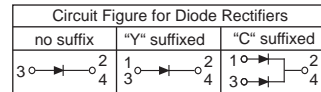
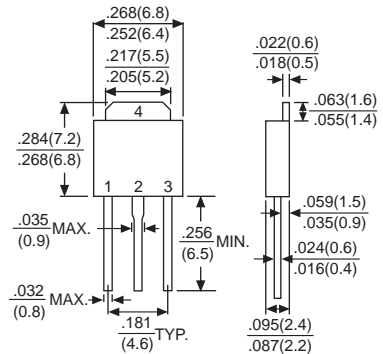

Dimensions in inches and (millimeters)

	SYMBOL	SD820	SD830	SD840	SD850	SD860	SD880	SD8100	SD8150	SD8200	UNITS
Maximum Recurrent Peak Reverse Voltage	V _{RRM}	20	30	40	50	60	80	100	150	200	Volts
Maximum RMS Voltage	V _{RMS}	14	21	28	35	42	56	70	105	140	Volts
Maximum DC Blocking Voltage	V _{DC}	20	30	40	50	60	80	100	150	200	Volts
Maximum Average Forward Rectified Current at T _A =100°C	I _O	8.0									Amps
Peak Forward Surge Current 8.3 ms single half sine-wave superimposed on rated load (JEDEC Method)	I _{FSM}	150									Amps
Maximum Instantaneous Forward Voltage at 4.0A DC for "C" suffixed", and at 8.0A DC for "Y suffixed" & "no suffix"	V _F	0.65		0.75		0.85		0.95			Volts
Maximum DC Reverse Current at Rated DC Blocking Voltage	I _R	@ T _A = 25°C									mAmps
		@ T _A = 100°C									
Typical Thermal Resistance (Note1)	R _{θJA}	80									°C/W
Typical Junction Capacitance (Note 2)	C _J	700									pF
Storage Operating Temperature Range	T _J , T _{STG}	-55 to + 125									°C

Note : 1. Mounted on PC Board with 14mm²(0.013mm thick) copper pad areas.

2. Measured at 1 MHz and applied reverse voltage of 4.0 volts.

RATING AND CHARACTERISTIC CURVES (SD820 THRU SD8200)

FIG. 1 - TYPICAL FORWARD CURRENT DERATING CURVE

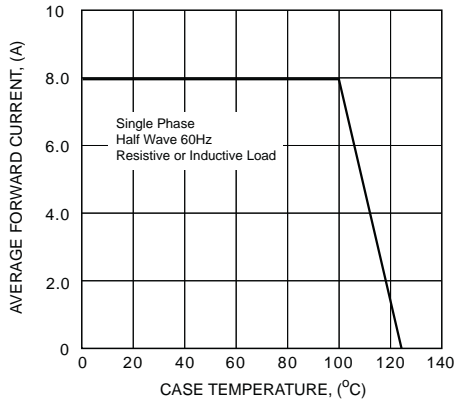

FIG. 2 - TYPICAL REVERSE CHARACTERISTICS

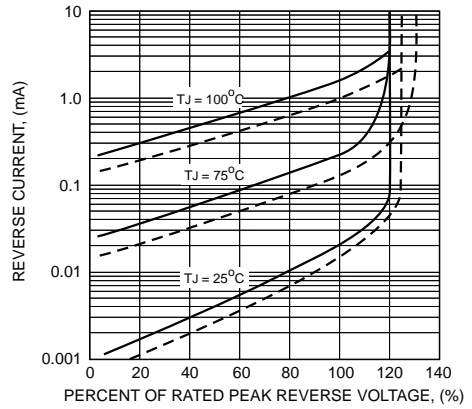

FIG. 3 - TYPICAL INSTANTANEOUS FORWARD CHARACTERISTICS

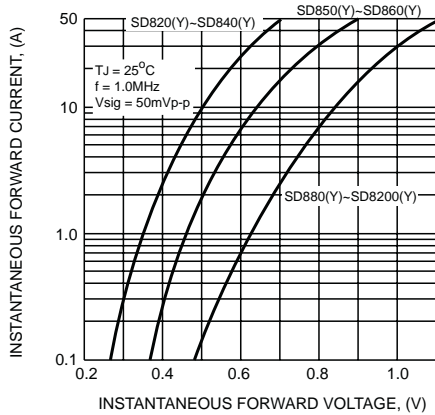

FIG. 4 - TYPICAL INSTANTANEOUS FORWARD CHARACTERISTICS

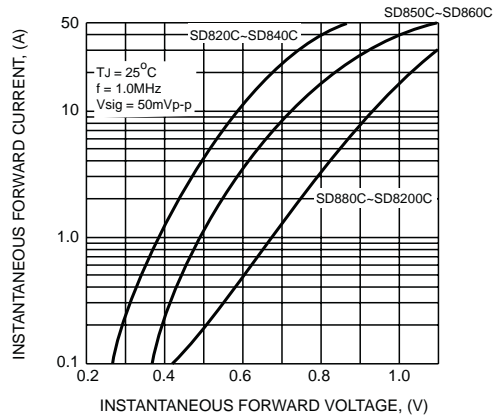

FIG. 5 - TYPICAL JUNCTION CAPACITANCE

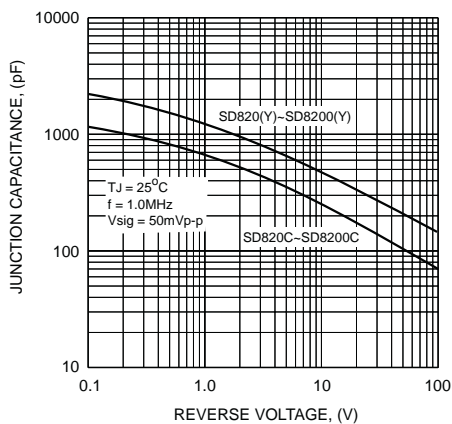
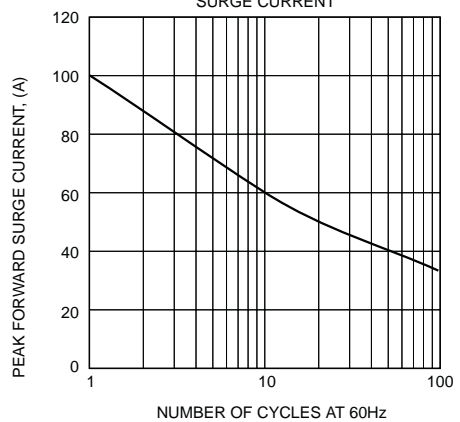

FIG. 6 - MAXIMUM NON-REPETITIVE FORWARD SURGE CURRENT



Disclaimer

Any Customer or user of this document or products described herein in such applications shall assume all risks of such use and will agree to hold *DC COMPONENTS* harmless against all damages.

DC COMPONENTS disclaims any and all liability arising out of the application or use of any product, including consequential or incidental damages. It is the customer's responsibility to validate that a particular product with the properties described in the product specification is suitable for use in a particular application.

DC COMPONENTS reserve the right to make modifications, enhancements, improvements, corrections or other changes without further notice to this document and any product described herein, and disclaim any and all liability for any errors, inaccuracies or incompleteness contained in any datasheet or in any other disclosure relating to any product.

Unless otherwise in writing, *DC COMPONENTS* products are intended for use as general electronic components in standard applications (eg: Consumer electronic, Computer equipment, Office equipment, etc.), and not recommended for use in a high specific application where a failure or malfunction of the device could result in human injury or death (eg: Aerospace equipment, Submarine cables, Combustion equipment, Safety devices, Life support systems, etc.)

Customers using or selling *DC COMPONENTS* products not expressly indicated for use in such applications do so at their own risk. If customer intended to use *DC COMPONENTS* standard quality grade devices for applications not envisioned by *DC COMPONENTS*, please contact our sales representatives in advance.



DC COMPONENTS CO., LTD.