



DC COMPONENTS CO., LTD.

RECTIFIER SPECIALISTS

DB3
THRU
DB4

TECHNICAL SPECIFICATIONS OF BIDIRECTIONAL DIODE THYRISTORS (DIACS)

FEATURES

- * Glass passivated three-layer for triggering thyristors.
- * Low breakover current at breakover voltage.
- * For use in thyristor phase-control circuit for lampdimming, universal-motor speed control and heat controls.

MECHANICAL DATA

- * Case: Glass sealed case
- * Lead: MIL-STD-202E, Method 208 guaranteed
- * Mounting position: Any
- * Weight: 0.15 gram

MAXIMUM RATINGS AND ELECTRICAL CHARACTERISTICS

Ratings at 25 °C ambient temperature unless otherwise specified.
Single phase, half wave, 60 Hz, resistive or inductive load.
For capacitive load, derate current by 20%.

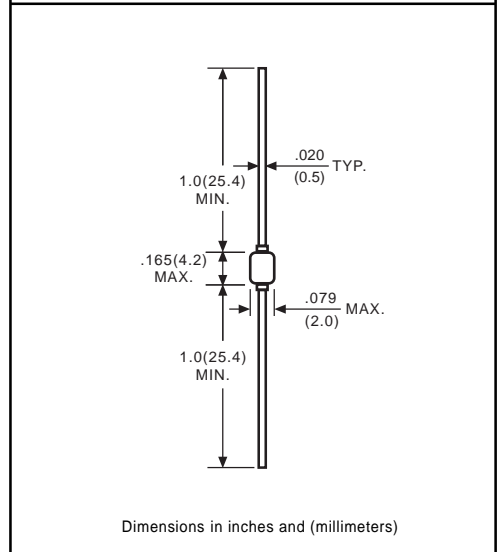
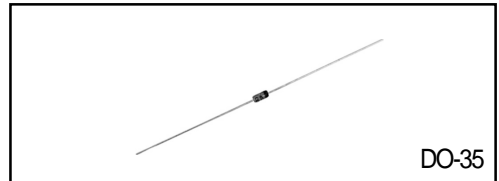

PARAMETERS	SYMBOL	DB3	DB4	UNITS
Breakover Voltage	+VBO, -VBO	28	35	VOLT
		32	40	Min
		36	45	Typ Max
Breakover Voltage Symmetry	(+VBO)-(-VBO)	3	3	VOLT Max
Dynamic Breakback Voltage	VBO - VBR	5	5	VOLT Min
Breakover Current	+IBO, -IBO	100	100	uA Max
Peak Pulse Current for 10uS, 120pps, TA<=40°C	IP	2.0	2.0	AMP Max

RATING AND CHARACTERISTIC CURVES (DB3 THRU DB4)

FIG.1-V-I CHARACTERISTICS CURRENT

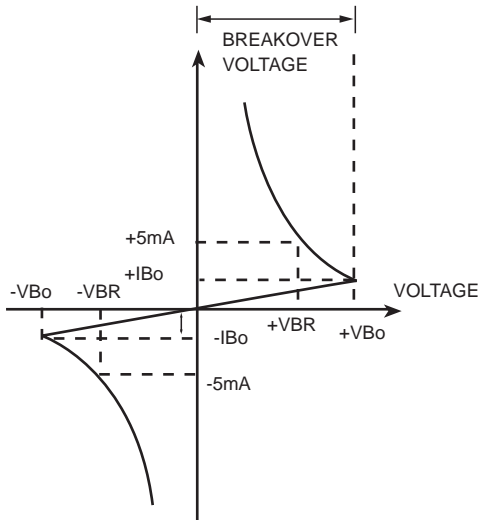

FIG.2-REPETITIVE PEAK ON-STATE CURRENT VS PULSE DURATION

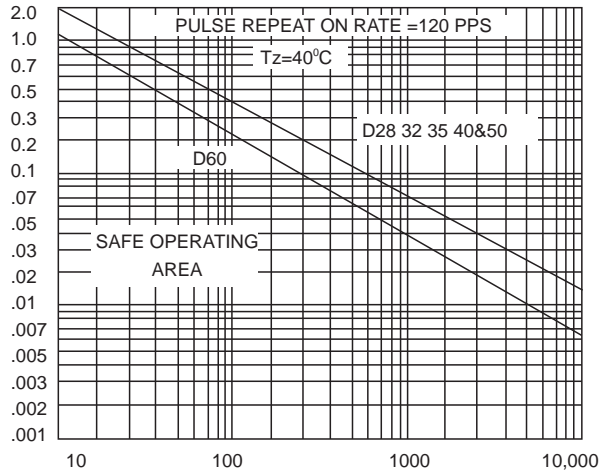

FIG.3-NORMALIZED VBO CHANGE VS JUNCTION TEMPERATURE

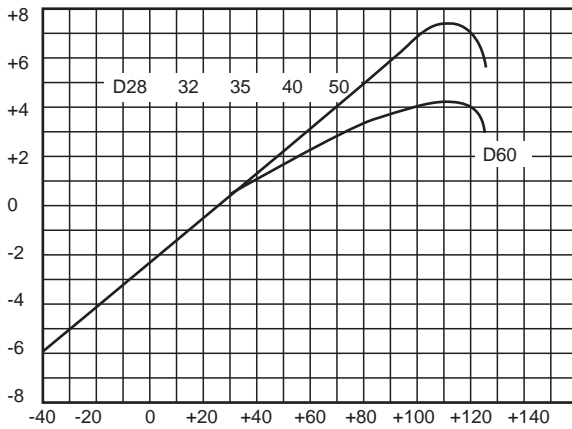

FIG.4-TEST CIRCUIT WAVE FORMS (SEE FIG.5)

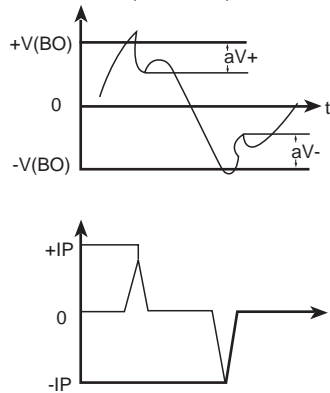
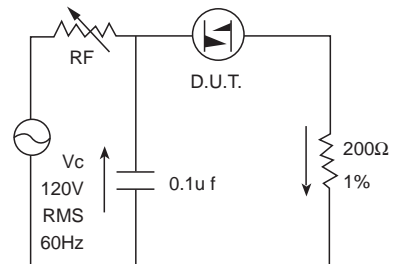

FIG.5-CIRCUIT USED TO MEASURE DIAC CHARACTERISTICS



*ADJUST FOR ONE FIRING IN HALF CYCLE



DC COMPONENTS CO., LTD.