



DC COMPONENTS CO., LTD.

RECTIFIER SPECIALISTS

SF21
THRU
SF28

TECHNICAL SPECIFICATIONS OF SUPER FAST RECTIFIER

VOLTAGE RANGE - 50 to 600 Volts

CURRENT - 2.0 Amperes

FEATURES

- * High reliability
- * Low leakage
- * Low forward voltage
- * High current capability
- * Super fast switching speed
- * High surge capability
- * Good for switching mode circuit

MECHANICAL DATA

- * Case: Molded plastic
- * Epoxy: UL 94V-0 rate flame retardant
- * Lead: MIL-STD-202E, Method 208 guaranteed
- * Mounting position: Any
- * Weight: 1.18 grams



DO-15

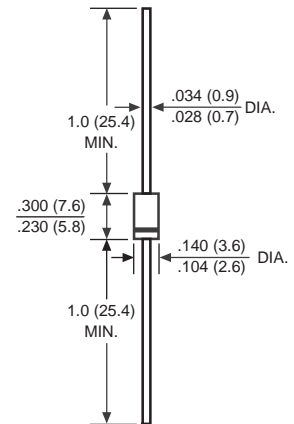

Dimensions in inches and (millimeters)

MAXIMUM RATINGS AND ELECTRICAL CHARACTERISTICS

Ratings at 25 °C ambient temperature unless otherwise specified.
Single phase, half wave, 60 Hz, resistive or inductive load.
For capacitive load, derate current by 20%.

	SYMBOL	SF21	SF22	SF23	SF24	SF25	SF26	SF28	UNITS	
Maximum Recurrent Peak Reverse Voltage	V _{RRM}	50	100	150	200	300	400	600	Volts	
Maximum RMS Volts	V _{RMS}	35	70	105	140	210	280	420	Volts	
Maximum DC Blocking Voltage	V _{DC}	50	100	150	200	300	400	600	Volts	
Maximum Average Forward Current at T _A = 55°C	I _O	2.0							Amps	
Peak Forward Surge Current I _{FM} (surge):8.3 ms single half sine-wave superimposed on rated load (JEDEC Method)	I _{FSM}	50							Amps	
Maximum Forward Voltage at 2.0A DC	V _F	0.95			1.40		1.85		Volts	
Maximum DC Reverse Current at Rated DC Blocking Voltage	I _R	@ T _A = 25°C							uAmps	
		5.0								
		200								
Maximum Reverse Recovery Time (Note 1)	t _{rr}	35							nSec	
Typical Junction Capacitance (Note 2)	C _J	30				20				pF
Operating and Storage Temperature Range	T _J , T _{STG}	-55 to + 150							°C	

NOTES : 1. Test Conditions: I_F=0.5A, I_R=1.0A, I_{RR}=0.25A.
2. Measured at 1 MHz and applied reverse voltage of 4.0 volts.

RATING AND CHARACTERISTIC CURVES (SF21 THRU SF28)

FIG. 1 - TEST CIRCUIT DIAGRAM AND REVERSE RECOVERY TIME CHARACTERISTIC

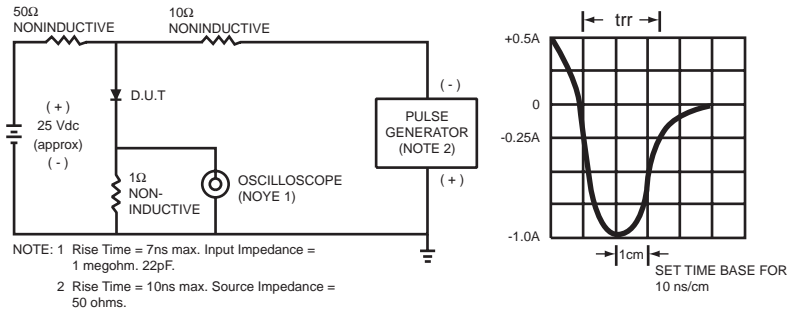

FIG. 2 - TYPICAL FORWARD CURRENT DERATING CURVE

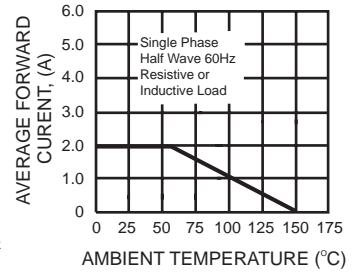

FIG. 3 - TYPICAL REVERSE CHARACTERISTICS

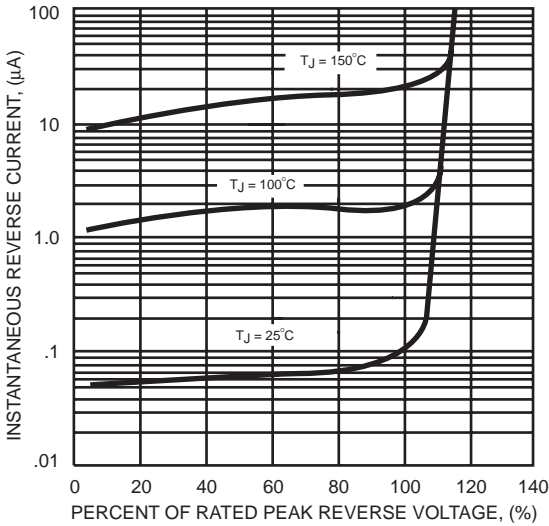

FIG. 4 - TYPICAL INSTANTANEOUS FORWARD CHARACTERISTICS

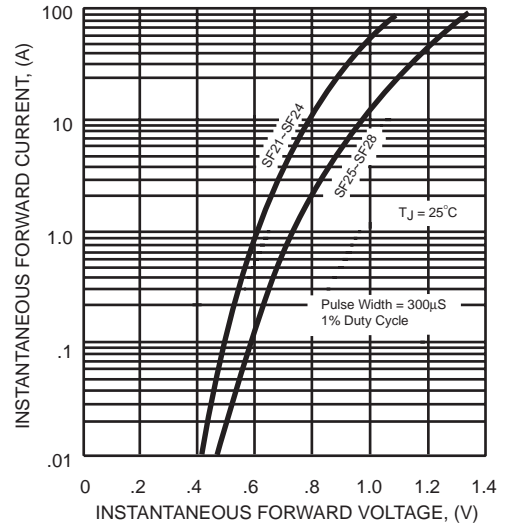

FIG. 5 - MAXIMUM NON-REPETITIVE FORWARD SURGE CURRENT

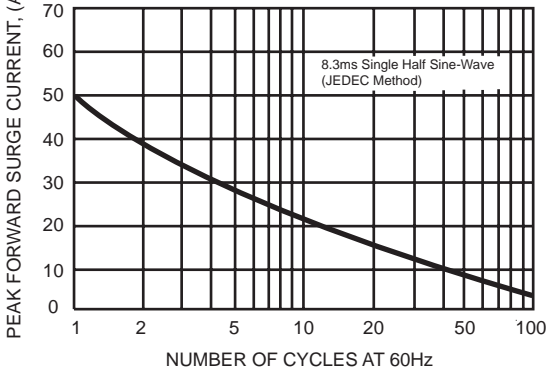
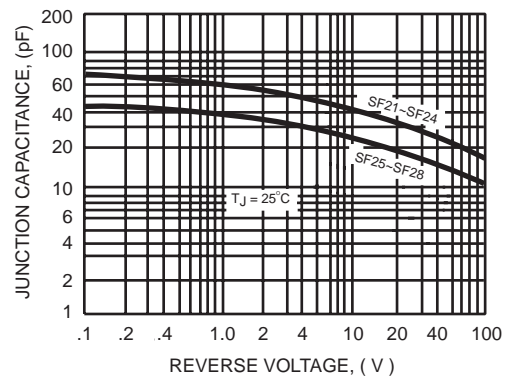

FIG. 6 - TYPICAL JUNCTION CAPACITANCE



Disclaimer

Any Customer or user of this document or products described herein in such applications shall assume all risks of such use and will agree to hold *DC COMPONENTS* harmless against all damages.

DC COMPONENTS disclaims any and all liability arising out of the application or use of any product, including consequential or incidental damages. Statement regarding the suitability of products for certain types of applications are based on *DC COMPONENTS*'s knowledge of typical requirements that are often placed on *DC COMPONENTS* products in generic applications. Such statements are not binding statements about the suitability of products for a particular application. It is the customer's responsibility to validate that a particular product with the properties described in the product specification is suitable for use in a particular application.

DC COMPONENTS reserve the right to make modifications, enhancements, improvements, corrections or other changes without further notice to this document and any product described herein, and disclaim any and all liability for any errors, inaccuracies or incompleteness contained in any datasheet or in any other disclosure relating to any product. Parameters provided in datasheets and specifications may vary in different applications and performance may vary over time. All operating parameters, including typical parameters, must be validated for each customer application by the customer's technical experts. Product specifications do not expand or otherwise modify *DC COMPONENTS*'s terms and conditions of purchase, including but not limited to the warranty expressed therein.

Unless otherwise in writing, *DC COMPONENTS* products are intended for use as general electronic components in standard applications (eg: Consumer electronic, Computer equipment, Office equipment, etc.), and not recommended for use in a high specific application where a failure or malfunction of the device could result in human injury or death (eg: Aerospace equipment, Submarine cables, Combustion equipment, Safety devices, Life support systems, etc.)

Customers using or selling *DC COMPONENTS* products not expressly indicated for use in such applications do so at their own risk. If customer intended to use *DC COMPONENTS* standard quality grade devices for applications not envisioned by *DC COMPONENTS*, please contact our sales representatives in advance.



DC COMPONENTS CO., LTD.