



DC COMPONENTS CO., LTD.
RECTIFIER SPECIALISTS

**5.0SMDJ11
THRU
5.0SMDJ440CA**

TECHNICAL SPECIFICATIONS OF TRANSIENT VOLTAGE SUPPRESSOR

VOLTAGE RANGE - 11 to 440Volts PEAK PULSE POWER - 5000 Watts

FEATURES

- * Glass passivated junction
- * 5000 Watts Peak Pulse Power capability on 10/1000 μ s waveform
- * Excellent clamping capability
- * Low zener impedance
- * Fast response time

MECHANICAL DATA

- * Case: Molded plastic
- * Epoxy: UL 94V-0 rate flame retardant
- * Terminals: Solder plated solderable per MIL-STD-750, Method 2026
- * Polarity: As marked
- * Mounting position: Any
- * Weight: 0.24 gram

MAXIMUM RATINGS AND ELECTRICAL CHARACTERISTICS

Ratings at 25°C ambient temperature unless otherwise specified.
Single phase, half wave, 60 Hz, resistive or inductive load,
For capacitive load, derate current by 20%.



SMC(DO-214AB)

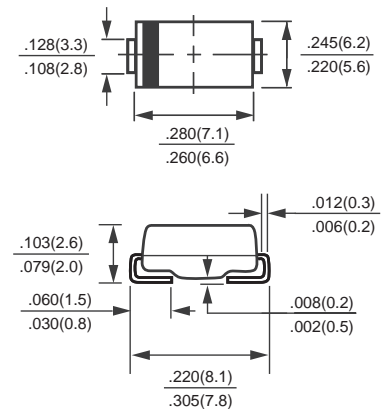

DEVICES FOR BIPOLAR APPLICATIONS

For Bidirectional use C or CA suffix (e.g. 5.0SMDJ11C, 5.0SMDJ440CA).

Electrical characteristics apply in both directions

	SYMBOL	VALUE	UNITS
Peak Pulse Power Dissipation on 10/1000 μ s waveform (Note 1, FIG. 1)	PPPM	Minimum 5000	Watts
Steady State Power Dissipation at T = 75°C Lead Lengths .375"(9.5mm) (Note 2)	P _{M(AV)}	6.5	Watts
Peak Forward Surge Current, 8.3ms single half sine-wave superimposed on rated load(JEDEC Method) (Note 3)	I _{FSM}	300	Amps
Maximum Instantaneous Forward Voltage at 50A for Unidirectional only	V _F	3.5	Volts
Operating and Storage Temperature Range	T _J , T _{STG}	-55 to + 175	°C

- NOTES :
1. Non-repetitive current pulse, per Fig.3 and derated above TA = 25°C per Fig.2
 2. Mounted on Copper Leaf area of 0.8 X 0.8" (20 X 20mm) per Fig.5
 3. 8.3ms single half sine-wave or equivalent square wave, duty cycle = 4 pulses per minute maximum.

RATING AND CHARACTERISTIC CURVES (5.0SMDJ11 THRU 5.0SMDJ440CA)

FIG. 1 - PEAK PULSE POWER RATING CURVE

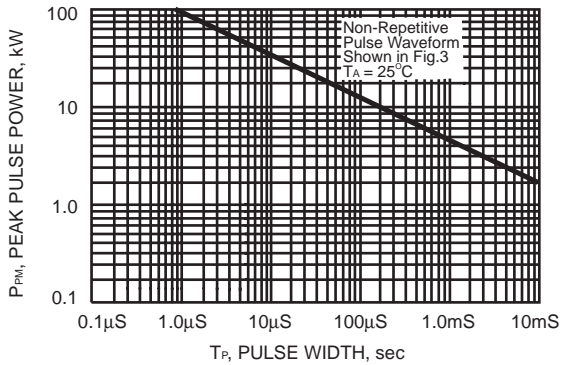

FIG. 2 - PULSE DERATING CURVE

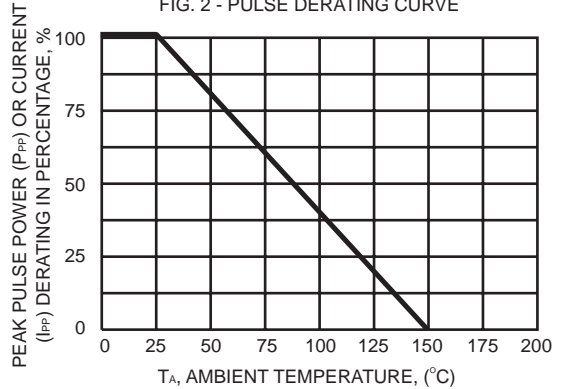

FIG. 3 - PULSE WAVEFORM

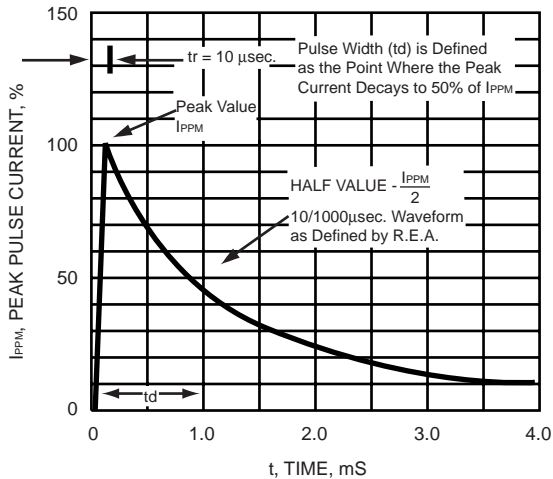

FIG. 4 - TYPICAL JUNCTION CAPACITANCE

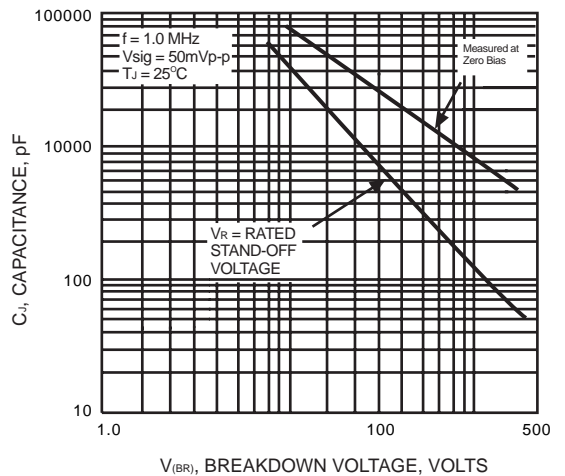

FIG. 5 - STEADY STATE POWER DERTING CURVE

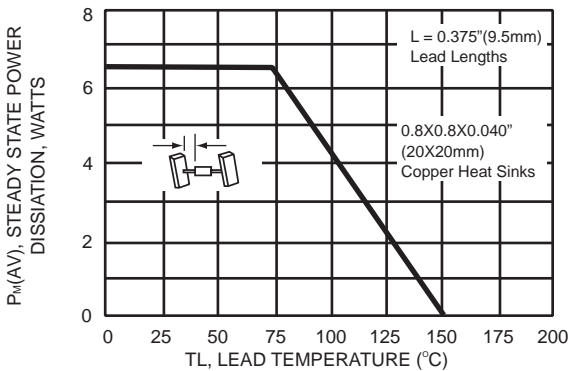
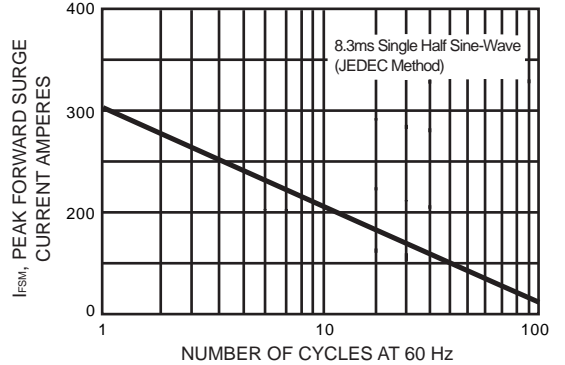

FIG. 6 - MAXIMUM NON-REPETITIVE FORWARD SURGE CURRENT UNIDIRECTIONAL



5.0SMDJ (5000W) SERIES TRANSIENT VOLTAGE SUPPRESSORS

TYPE	Reverse Stand-off Voltage	Breakdown Voltage @ I _T		Test Current	Maximum Reverse Leakage @ V _{RWM}		Maximum Clamping Voltage @ I _{PP}	Maximum Peak Pulse Current
	V _{RWM} V	V _{BR}		I _T mA	I _R		V _c V	I _{PP} A
		Min.	Max.		UNI- μA	BI- μA		
		V	V					
5.0SMDJ11	11	12.2	14.9	1	800		20.1	251.24
5.0SMDJ11A	11	12.2	13.5	1	800		18.2	277.47
5.0SMDJ12	12	13.3	16.3	1	800		22.0	229.55
5.0SMDJ12A	12	13.3	14.7	1	800		19.9	253.77
5.0SMDJ13	13	14.4	17.6	1	500		23.8	212.18
5.0SMDJ13A	13	14.4	15.9	1	500		21.5	234.88
5.0SMDJ14	14	15.6	19.1	1	200		25.8	195.74
5.0SMDJ14A	14	15.6	17.2	1	200		23.2	217.67
5.0SMDJ15	15	16.7	20.4	1	100		26.9	187.73
5.0SMDJ15A	15	16.7	18.5	1	100		24.4	206.97
5.0SMDJ16	16	17.8	21.8	1	50		28.8	175.35
5.0SMDJ16A	16	17.8	19.7	1	50		26.0	194.23
5.0SMDJ17	17	18.9	23.1	1	20		30.5	165.57
5.0SMDJ17A	17	18.9	20.9	1	20		27.6	182.97
5.0SMDJ18	18	20.0	24.4	1	10		32.2	156.83
5.0SMDJ18A	18	20.0	22.1	1	10		29.2	172.95
5.0SMDJ19	19	21.13	25.76	1	10		34.0	148.49
5.0SMDJ19A	19	21.13	23.3	1	10		30.8	164.07
5.0SMDJ20	20	22.2	27.1	1	5		35.8	141.06
5.0SMDJ20A	20	22.2	24.5	1	5		32.4	155.86
5.0SMDJ22	22	24.4	29.8	1	5		39.4	128.17
5.0SMDJ22A	22	24.4	26.9	1	5		35.5	142.25
5.0SMDJ24	24	26.7	32.6	1	5		43.0	117.44
5.0SMDJ24A	24	26.7	29.5	1	5		38.9	129.82
5.0SMDJ26	26	28.9	35.3	1	5		46.6	108.37
5.0SMDJ26A	26	28.9	31.9	1	5		42.1	119.95
5.0SMDJ28	28	31.1	38.0	1	5		50.0	101.00
5.0SMDJ28A	28	31.1	34.4	1	5		45.4	111.23
5.0SMDJ30	30	33.3	40.7	1	5		53.5	94.39
5.0SMDJ30A	30	33.3	36.8	1	5		48.4	104.34
5.0SMDJ33	33	36.7	44.9	1	5		59.0	85.59
5.0SMDJ33A	33	36.7	40.6	1	5		53.3	94.75
5.0SMDJ36	36	40.0	48.9	1	5		64.3	78.54
5.0SMDJ36A	36	40.0	44.2	1	5		58.1	86.92
5.0SMDJ40	40	44.4	54.3	1	5		71.4	70.73
5.0SMDJ40A	40	44.4	49.1	1	5		64.5	78.29
5.0SMDJ43	43	47.8	58.4	1	5		76.7	65.84
5.0SMDJ43A	43	47.8	52.8	1	5		69.4	72.77
5.0SMDJ45	45	50.0	61.1	1	5		80.3	62.89
5.0SMDJ45A	45	50.0	55.3	1	5		72.7	69.46
5.0SMDJ48	48	53.3	65.1	1	5		85.5	59.06
5.0SMDJ48A	48	53.3	58.9	1	5		77.4	65.25
5.0SMDJ51	51	56.7	69.3	1	5		91.1	55.43
5.0SMDJ51A	51	56.7	62.7	1	5		82.4	61.29
5.0SMDJ54	54	60.0	73.3	1	5		96.3	52.44
5.0SMDJ54A	54	60.0	66.3	1	5		87.1	57.98
5.0SMDJ58	58	64.4	78.7	1	5		103	49.03
5.0SMDJ58A	58	64.4	71.2	1	5		93.6	53.95
5.0SMDJ60	60	66.7	81.5	1	5		107	47.20
5.0SMDJ60A	60	66.7	73.7	1	5		96.8	52.17

5.0SMDJ (5000W) SERIES TRANSIENT VOLTAGE SUPPRESSORS

TYPE	Reverse Stand-off Voltage	Breakdown Voltage @ I_T		Test Current	Maximum Reverse Leakage @ V_{RWM}		Maximum Clamping Voltage @ I_{PP}	Maximum Peak Pulse Current
		V_{BR}			I_R			
	V_{RWM}	Min. V	Max. V	I_T mA	UNI- μA	BI- μA	V_C V	I_{PP} A
5.0SMDJ64	64	71.1	86.9	1	5		114	44.30
5.0SMDJ64A	64	71.1	78.6	1	5		103	49.03
5.0SMDJ70	70	77.8	95.1	1	5		125	40.40
5.0SMDJ70A	70	77.8	86.0	1	5		113	44.69
5.0SMDJ75	75	83.3	102	1	5		134	37.69
5.0SMDJ75A	75	83.3	92.1	1	5		121	41.74
5.0SMDJ78	78	86.7	106	1	5		139	36.33
5.0SMDJ78A	78	86.7	95.8	1	5		126	40.08
5.0SMDJ80	80	88.8	108.8	1	5		143.2	35.27
5.0SMDJ80A	80	88.8	97.6	1	5		129.6	38.97
5.0SMDJ85	85	94.4	115	1	5		151	33.44
5.0SMDJ85A	85	94.4	104	1	5		137	36.86
5.0SMDJ90	90	100	122	1	5		160	31.56
5.0SMDJ90A	90	100	111	1	5		146	34.59
5.0SMDJ100	100	111	136	1	5		179	28.21
5.0SMDJ100A	100	111	123	1	5		162	31.17
5.0SMDJ110	110	122	149	1	5		196	25.77
5.0SMDJ110A	110	122	135	1	5		177	28.53
5.0SMDJ120	120	133	163	1	5		214	23.60
5.0SMDJ120A	120	133	147	1	5		193	26.17
5.0SMDJ130	130	144	176	1	5		231	21.86
5.0SMDJ130A	130	144	159	1	5		209	24.16
5.0SMDJ140	140	155	190.4	1	5		250.6	20.15
5.0SMDJ140A	140	155	171	1	5		226.8	22.27
5.0SMDJ150	150	167	204	1	5		268	18.84
5.0SMDJ150A	150	167	185	1	5		243	20.78
5.0SMDJ160	160	178	218	1	5		287	17.60
5.0SMDJ160A	160	178	197	1	5		259	19.50
5.0SMDJ170	170	189	231	1	5		304	16.61
5.0SMDJ170A	170	189	209	1	5		275	18.36
5.0SMDJ180	180	200	244.8	1	5		322.2	15.67
5.0SMDJ180A	180	200	220	1	5		291.6	17.32
5.0SMDJ190	190	211	258.4	1	5		340.1	14.85
5.0SMDJ190A	190	211	232	1	5		307.8	16.41
5.0SMDJ200A	200	224	247	1	5		324	9.26
5.0SMDJ220A	220	246	272	1	5		356	8.43
5.0SMDJ250A	250	279	309	1	5		405	7.41
5.0SMDJ300A	300	335	371	1	5		486	6.17
5.0SMDJ350A	350	391	432	1	5		567	5.29
5.0SMDJ400A	400	447	494	1	5		648	4.63
5.0SMDJ440A	440	492	543	1	5		713	4.21

- NOTES: 1. V_{BR} measured after I_T applied for 300 μs . I_T = Square Wave Pulse or equivalent.
 2. For bidirectional use "C" or "CA" suffixes for all types (e.g.: 5.0SMDJ5.0C, 5.0SMDJ5.0CA, 5.0SMDJ440C, 5.0SMDJ440CA). Electrical characteristics apply in both directions.
 3. For bidirectional types having V_{RWM} of 10 volts and less, the I_D limit is doubled.

Disclaimer

Any Customer or user of this document or products described herein in such applications shall assume all risks of such use and will agree to hold *DC COMPONENTS* harmless against all damages.

DC COMPONENTS disclaims any and all liability arising out of the application or use of any product, including consequential or incidental damages. Statement regarding the suitability of products for certain types of applications are based on *DC COMPONENTS*'s knowledge of typical requirements that are often placed on *DC COMPONENTS* products in generic applications. Such statements are not binding statements about the suitability of products for a particular application. It is the customer's responsibility to validate that a particular product with the properties described in the product specification is suitable for use in a particular application.

DC COMPONENTS reserve the right to make modifications, enhancements, improvements, corrections or other changes without further notice to this document and any product described herein, and disclaim any and all liability for any errors, inaccuracies or incompleteness contained in any datasheet or in any other disclosure relating to any product. Parameters provided in datasheets and specifications may vary in different applications and performance may vary over time. All operating parameters, including typical parameters, must be validated for each customer application by the customer's technical experts. Product specifications do not expand or otherwise modify *DC COMPONENTS*'s terms and conditions of purchase, including but not limited to the warranty expressed therein.

Unless otherwise in writing, *DC COMPONENTS* products are intended for use as general electronic components in standard applications (eg: Consumer electronic, Computer equipment, Office equipment, etc.), and not recommended for use in a high specific application where a failure or malfunction of the device could result in human injury or death (eg: Aerospace equipment, Submarine cables, Combustion equipment, Safety devices, Life support systems, etc.)

Customers using or selling *DC COMPONENTS* products not expressly indicated for use in such applications do so at their own risk. If customer intended to use *DC COMPONENTS* standard quality grade devices for applications not envisioned by *DC COMPONENTS*, please contact our sales representatives in advance.



DC COMPONENTS CO., LTD.