



**DC COMPONENTS CO., LTD.**

RECTIFIER SPECIALISTS

KBPC / MB  
35005 / 3505

THRU

KBPC / MB  
3510 / 3510

**TECHNICAL SPECIFICATIONS OF SINGLE-PHASE SILICON BRIDGE RECTIFIER**

**VOLTAGE RANGE - 50 to 1000 Volts**

**CURRENT - 35 Amperes**

**FEATURES**

- \* Metal case for Maximum Heat Dissipation
- \* Surge overload ratings-400 Amperes
- \* Low forward voltage drop

**MECHANICAL DATA**

- \* Case: Metal, electrically isolated
- \* Epoxy: UL 94V-0 rate flame retardant
- \* Terminals: Plated .25"(6.35mm) Faston lugs, solderable per MIL-STD-202E, Method 208 guaranteed
- \* Polarity: As marked
- \* Mounting position: Any
- \* Weight: 30 grams

**MAXIMUM RATINGS AND ELECTRICAL CHARACTERISTICS**

Ratings at 25 °C ambient temperature unless otherwise specified.  
Single phase, half wave, 60 Hz, resistive or inductive load.  
For capacitive load, derate current by 20%.



MB-25

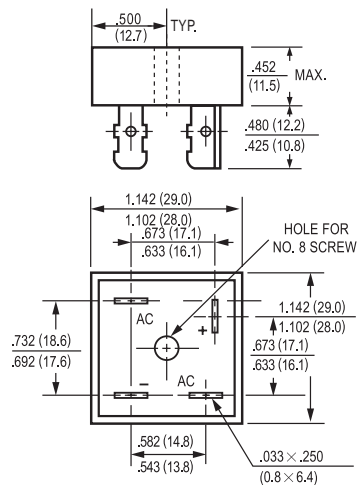

	KBPC 35005	KBPC 3501	KBPC 3502	KBPC 3504	KBPC 3506	KBPC 3508	KBPC 3510
--	---------------	--------------	--------------	--------------	--------------	--------------	--------------

	SYMBOL	MB3505	MB351	MB352	MB354	MB356	MB358	MB3510	UNITS
Maximum Recurrent Peak Reverse Voltage	V <sub>RRM</sub>	50	100	200	400	600	800	1000	Volts
Maximum RMS Bridge Input Voltage	V <sub>RMS</sub>	35	70	140	280	420	560	700	Volts
Maximum DC Blocking Voltage	V <sub>DC</sub>	50	100	200	400	600	800	1000	Volts
Maximum Average Forward Rectified Output Current at T <sub>c</sub> = 55°C	I <sub>o</sub>	35							Amps
Peak Forward Surge Current 8.3 ms single half sine-wave superimposed on rated load (JEDEC Method)	I <sub>FSM</sub>	400							Amps
Maximum Forward Voltage Drop per element at 17.5A DC	V <sub>F</sub>	1.1							Volts
Maximum DC Reverse Current at Rated	I <sub>R</sub>	@ T <sub>A</sub> = 25°C							uAmps
DC Blocking Voltage per element		@ T <sub>A</sub> = 100°C							
I <sup>2</sup> t Rating for Fusing (t<8.3ms)	I <sup>2</sup> t	664							A <sup>2</sup> Sec
Typical Junction Capacitance ( Note1)	C <sub>J</sub>	300							pF
Typical Thermal Resistance (Note 2)	R <sub>θJC</sub>	2.2							°C/W
Operating and Storage Temperature Range	T <sub>J</sub> ,T <sub>STG</sub>	-55 to + 150							°C

NOTES : 1.Measured at 1 MHz and applied reverse voltage of 4.0 volts  
2. Thermal Resistance from Junction to Case per leg.

RATING AND CHARACTERISTIC CURVES

( KBPC35005 THRU KBPC3510  
MB3505 MB3510 )

FIG. 1 - MAXIMUM NON-REPETITIVE FORWARD SURGE CURRENT

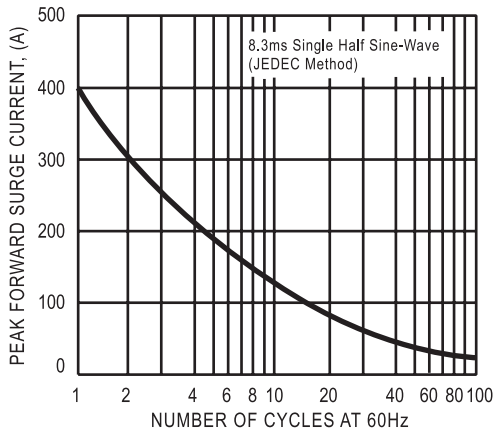

FIG. 2 - TYPICAL FORWARD CURRENT DERATING CURVE

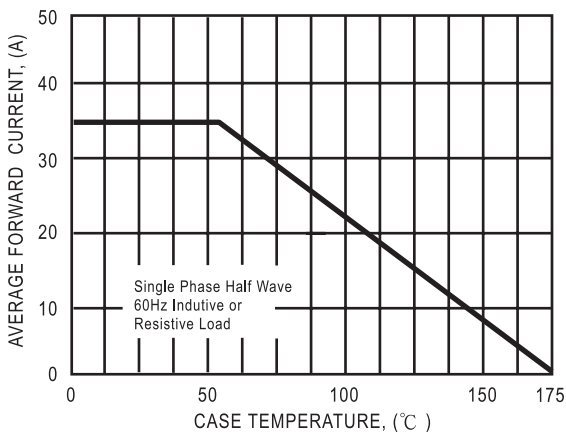

FIG. 3- TYPICAL INSTANTANEOUS FORWARD CHARACTERISTICS

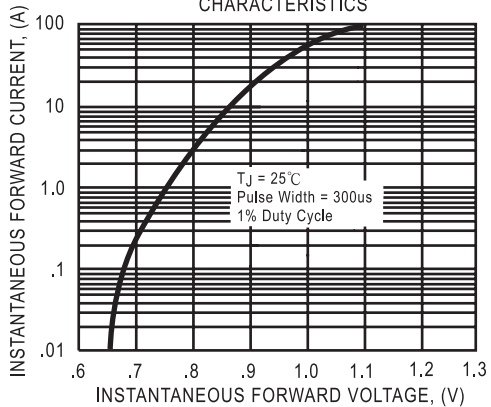
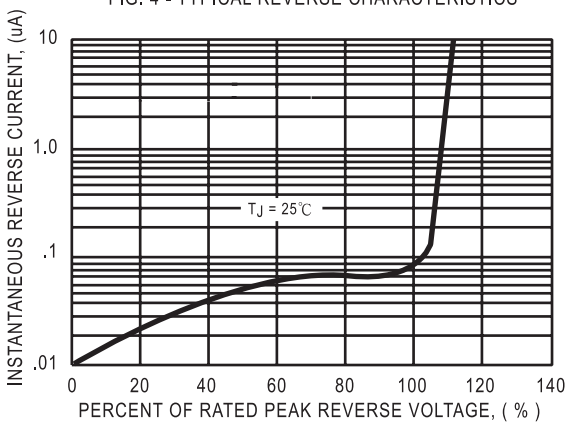

FIG. 4 - TYPICAL REVERSE CHARACTERISTICS





**DC COMPONENTS CO., LTD.**

RECTIFIER SPECIALISTS

KBPC / MB  
35005W / 3505W  
THRU  
KBPC / MB  
3510W / 3510W

**TECHNICAL SPECIFICATIONS OF SINGLE-PHASE SILICON BRIDGE RECTIFIER**

VOLTAGE RANGE - 50 to 1000 Volts

CURRENT - 35 Amperes

**FEATURES**

- \* Metal case Maximum Heat Dissipation
- \* Surge overload ratings-400 Amperes
- \* Low forward voltage drop

**MECHANICAL DATA**

- \* Case: Metal, electrically isolated
- \* Epoxy: UL 94V-0 rate flame retardant
- \* Lead: MIL-STD-202E, Method 208 guaranteed
- \* Polarity: As marked
- \* Mounting position: Any
- \* Weight: 30 grams

**MAXIMUM RATINGS AND ELECTRICAL CHARACTERISTICS**

Ratings at 25 °C ambient temperature unless otherwise specified.  
Single phase, half wave, 60 Hz, resistive or inductive load.  
For capacitive load, derate current by 20%.



MB-25W

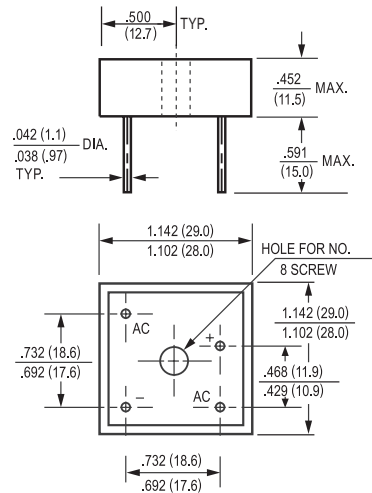

	KBPC 35005W	KBPC 3501W	KBPC 3502W	KBPC 3504W	KBPC 3506W	KBPC 3508W	KBPC 3510W
--	----------------	---------------	---------------	---------------	---------------	---------------	---------------

	SYMBOL	MB3505W	MB351W	MB352W	MB354W	MB356W	MB358W	MB3510W	UNITS
Maximum Recurrent Peak Reverse Voltage	V <sub>RRM</sub>	50	100	200	400	600	800	1000	Volts
Maximum RMS Bridge Input Voltage	V <sub>RMS</sub>	35	70	140	280	420	560	700	Volts
Maximum DC Blocking Voltage	V <sub>DC</sub>	50	100	200	400	600	800	1000	Volts
Maximum Average Forward Rectified Output Current at T <sub>c</sub> = 55°C	I <sub>o</sub>	35							Amps
Peak Forward Surge Current 8.3 ms single half sine-wave superimposed on rated load (JEDEC Method)	I <sub>FSM</sub>	400							Amps
Maximum Forward Voltage Drop per element at 17.5A DC	V <sub>F</sub>	1.1							Volts
Maximum DC Reverse Current at Rated DC Blocking Voltage per element	@ T <sub>A</sub> = 25°C	10							uAmps
	@ T <sub>A</sub> = 100°C	500							
I <sup>2</sup> t Rating for Fusing (t<8.3ms)	I <sup>2</sup> t	664							A <sup>2</sup> Sec
Typical Junction Capacitance ( Note1)	C <sub>J</sub>	300							pF
Typical Thermal Resistance ( Note 2)	R <sub>θJC</sub>	2.2							°C/W
Operating and Storage Temperature Range	T <sub>J</sub> ,T <sub>STG</sub>	-55 to + 150							°C

NOTES : 1.Measured at 1 MHz and applied reverse voltage of 4.0 volts  
2. Thermal Resistance from Junction to Case per leg.

RATING AND CHARACTERISTIC CURVES

( KBPC35005W MB3505W THRU KBPC3510W MB3510W )

FIG. 1 - MAXIMUM NON-REPETITIVE FORWARD SURGE CURRENT

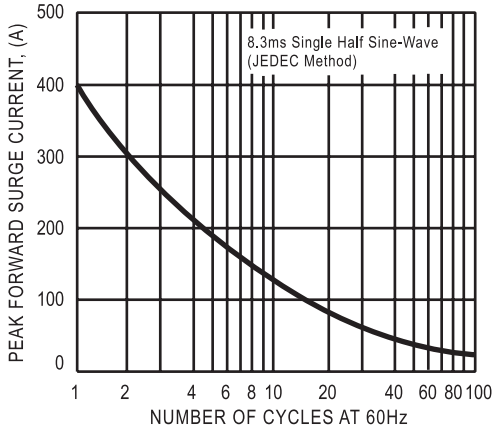

FIG. 2 - TYPICAL FORWARD CURRENT DERATING CURVE

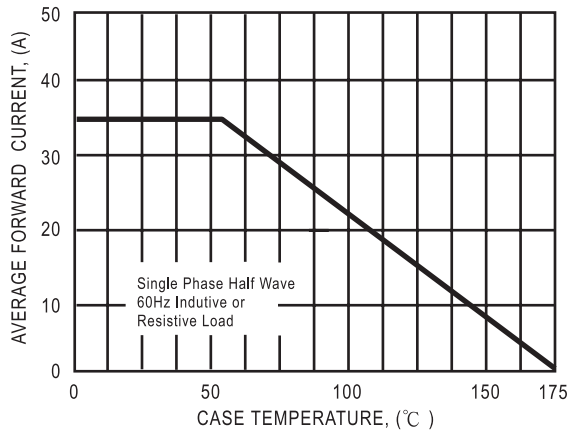

FIG. 3- TYPICAL INSTANTANEOUS FORWARD CHARACTERISTICS

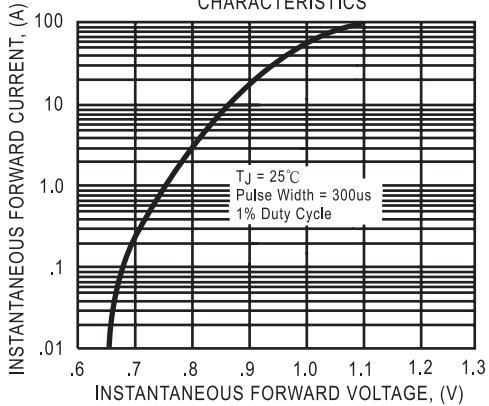

FIG. 4 - TYPICAL REVERSE CHARACTERISTICS

